

Angel

www.Origami-imagirO.de
Copyright (c) 2006 Dominik Meissner

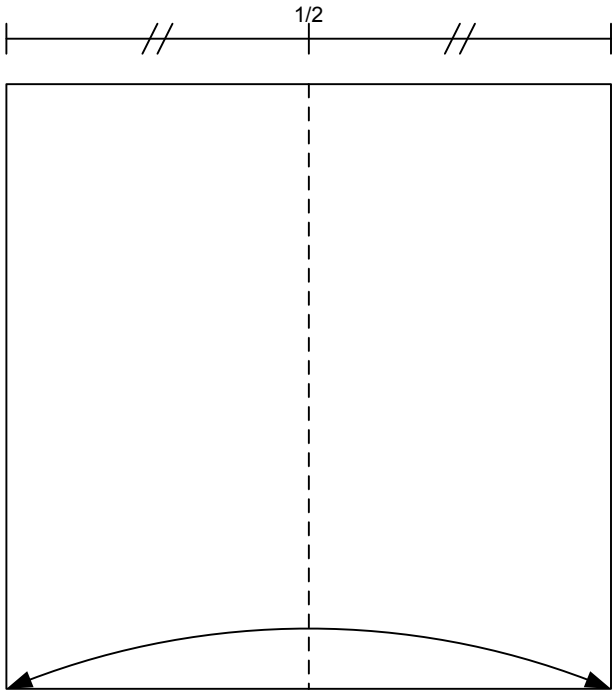

1

fold 1/2

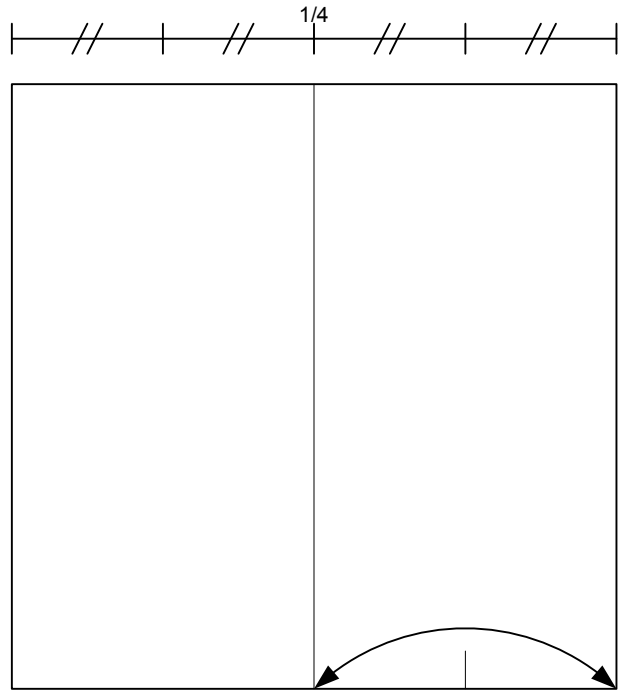

2

mark 1/4

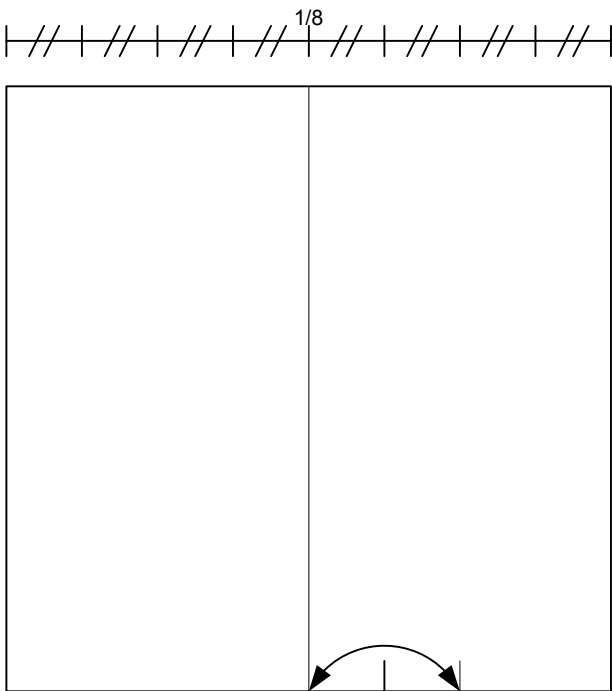

3

mark 1/8

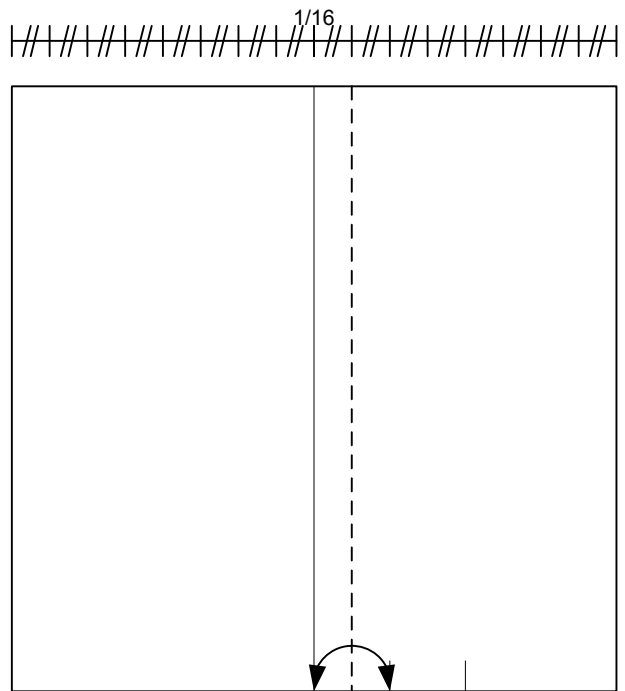

4

fold 1/16

Angel

www.Origami-imagirO.de
Copyright (c) 2006 Dominik Meissner

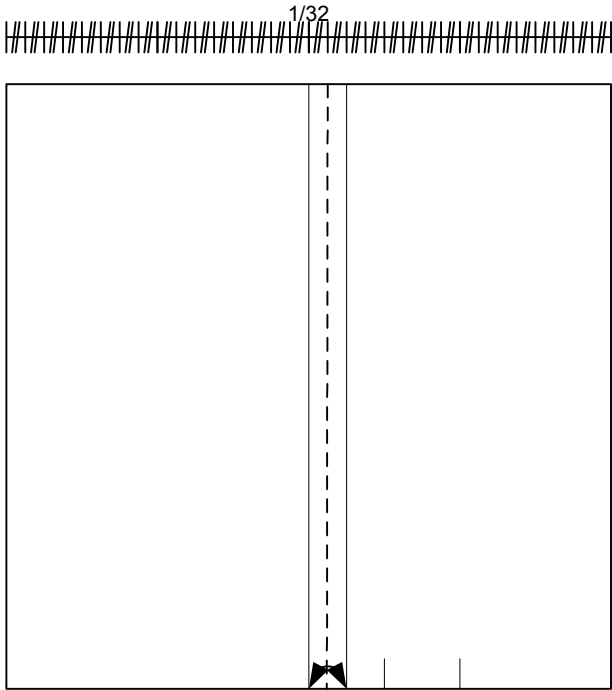

5

fold 1/32

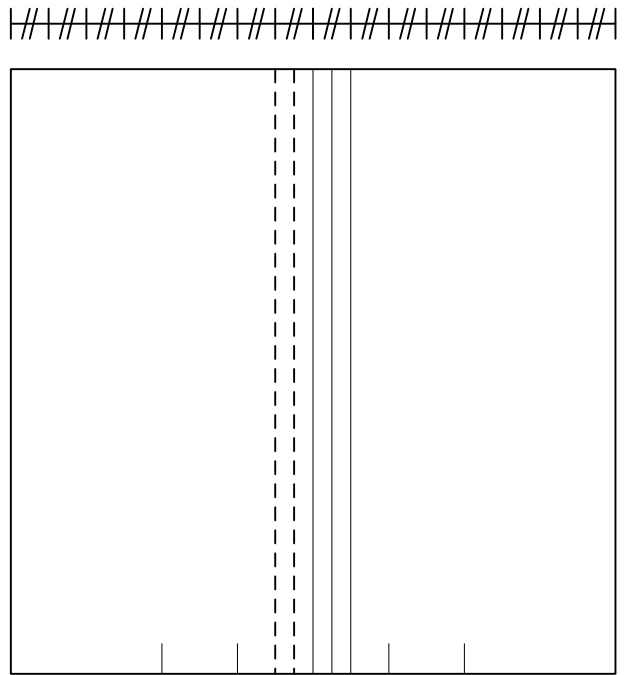

6

repeat the other side

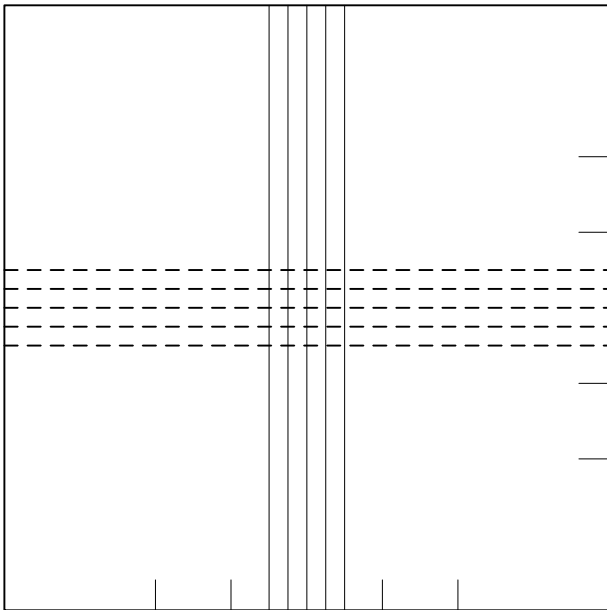

7

repeat horizontal

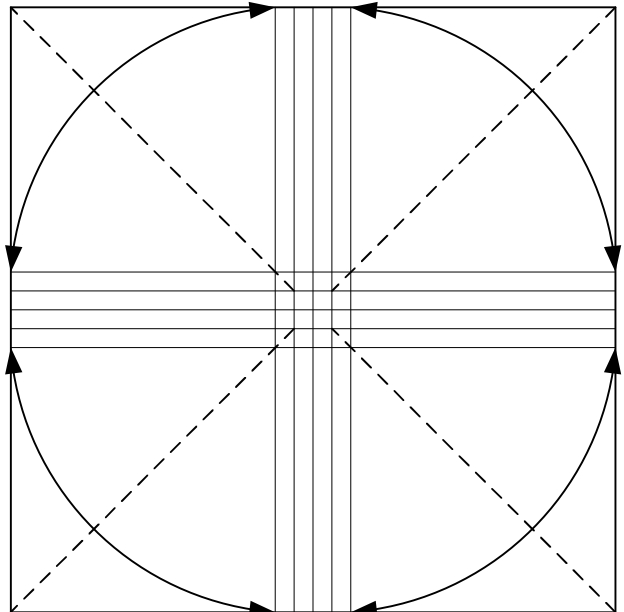

8

leave the quadrate in the middle unfolded. It's the top of the head

Angel

www.Origami-imagirO.de
Copyright (c) 2006 Dominik Meissner

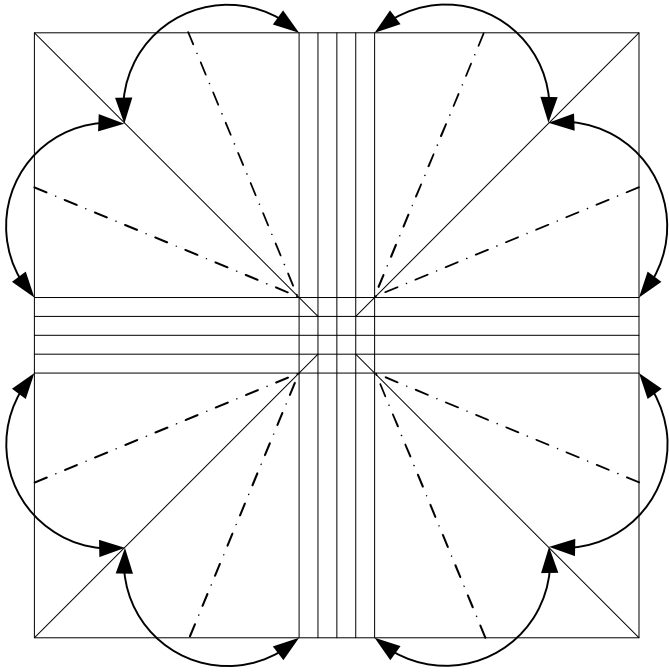

9

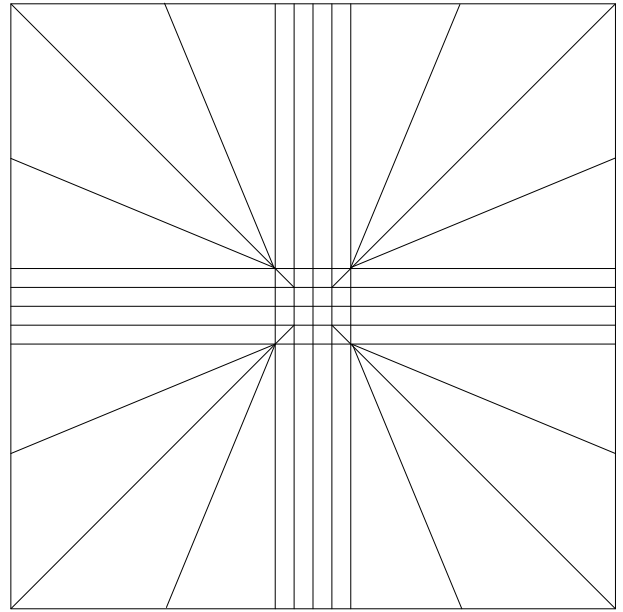

10

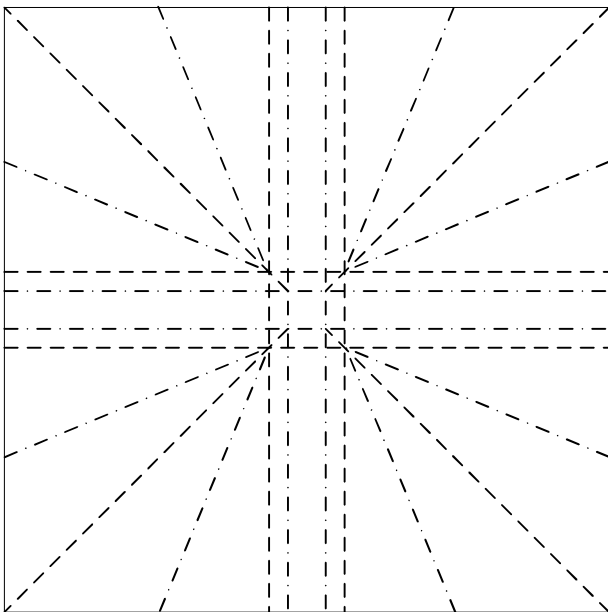

11

fold all together

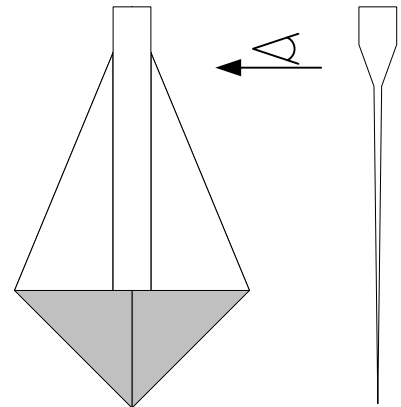

12

don't compress the head
the head looks like a cube

Angel

www.Origami-imagirO.de
Copyright (c) 2006 Dominik Meissner

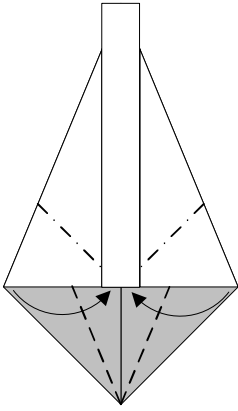

13

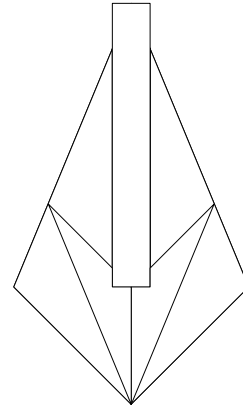

14

repeat the 3 other layer

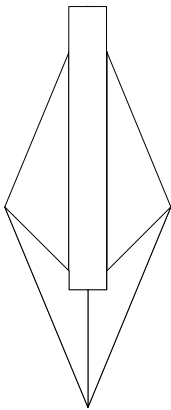

15

frogbase

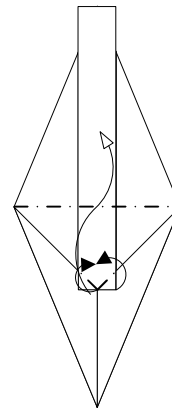

16

insert layer

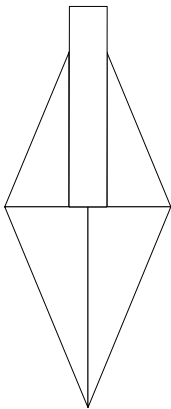

17

repeat only 2 other layer
leave one layer as it is

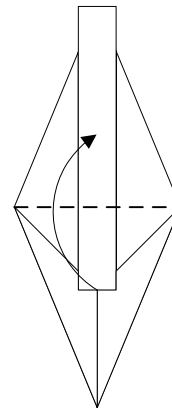
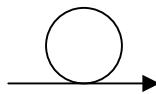

18

Angel

www.Origami-imagirO.de
Copyright (c) 2006 Dominik Meissner

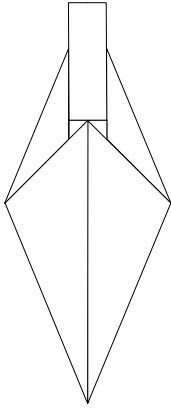

19

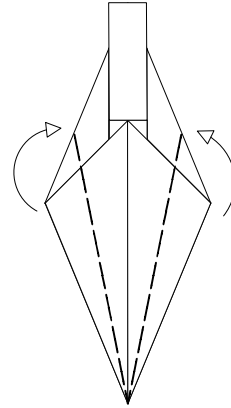

20

fold back the top layer

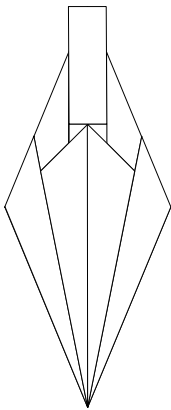

21

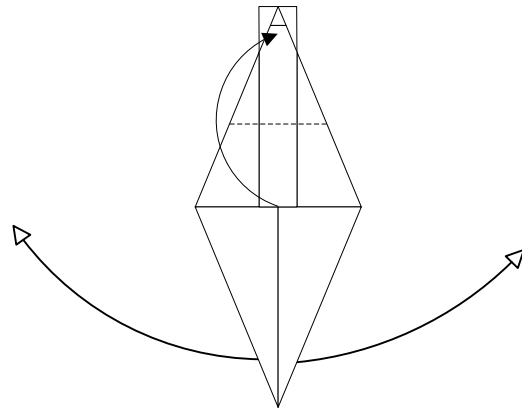
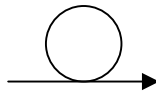

22

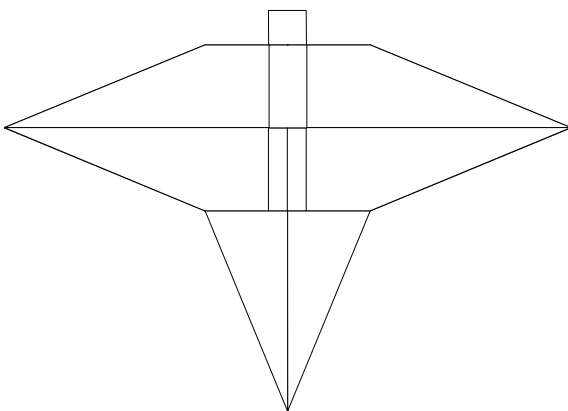

23

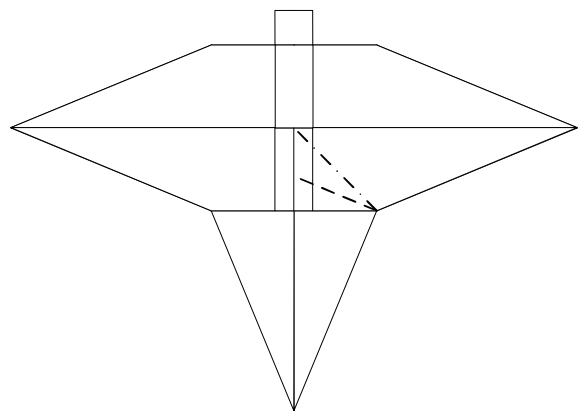

24

make two rabbit ear

Angel

www.Origami-imagirO.de
Copyright (c) 2006 Dominik Meissner

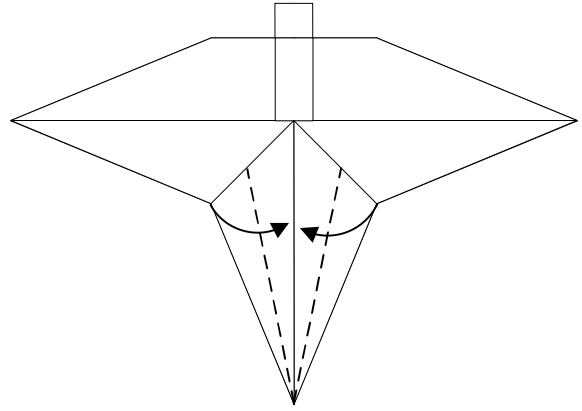
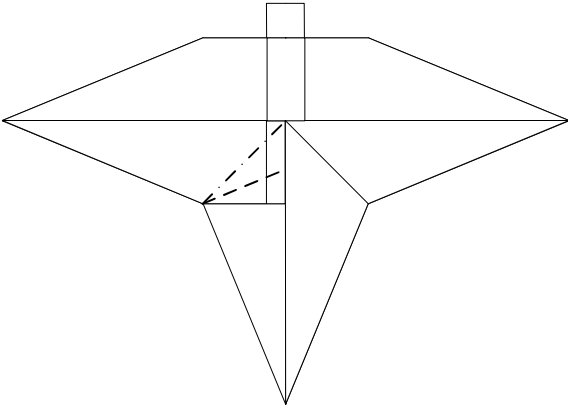

25

repeat the other layer

26

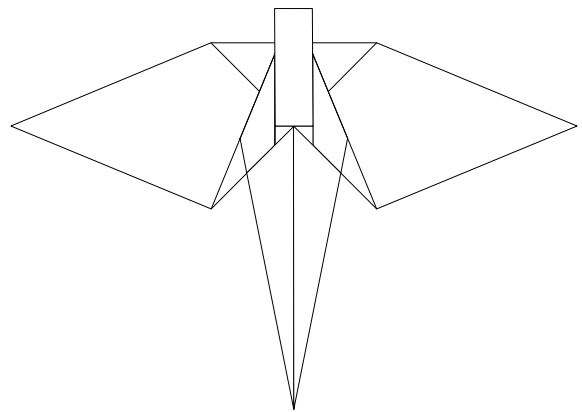
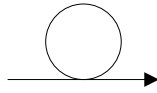
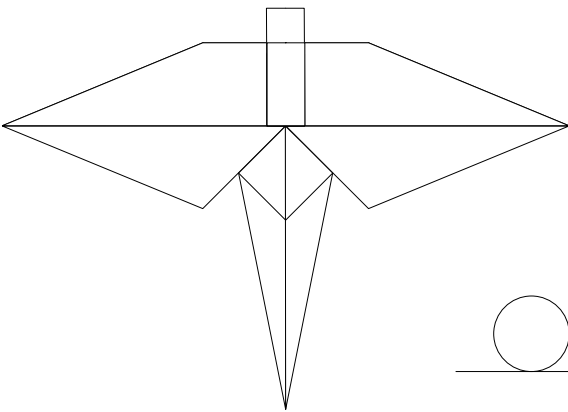

27

28

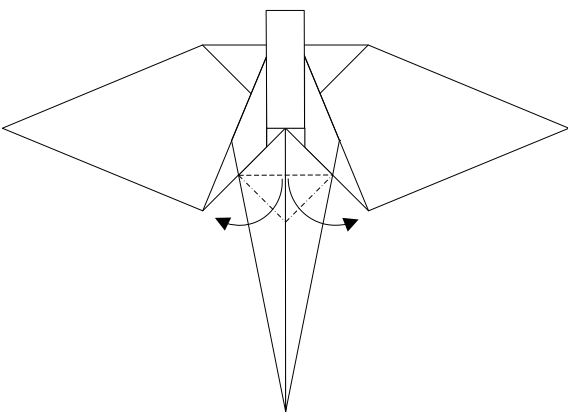

29

open layer

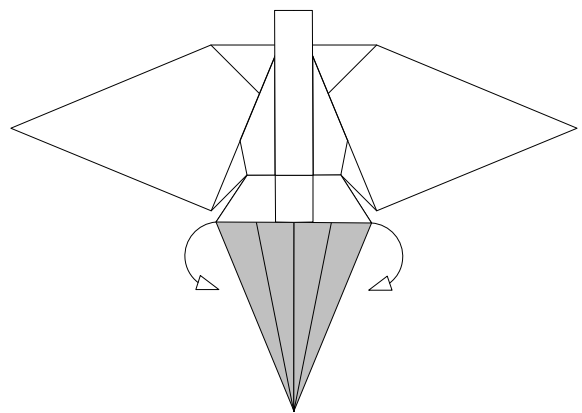

30

fold layer back

Angel

www.Origami-imagirO.de
Copyright (c) 2006 Dominik Meissner

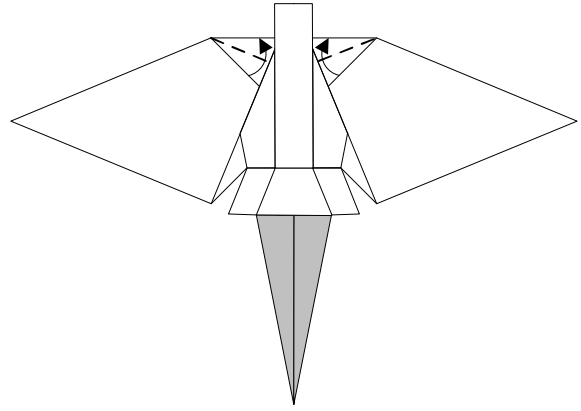
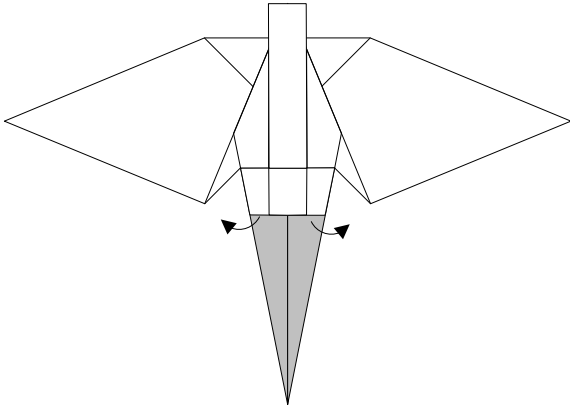

31

open layer

32

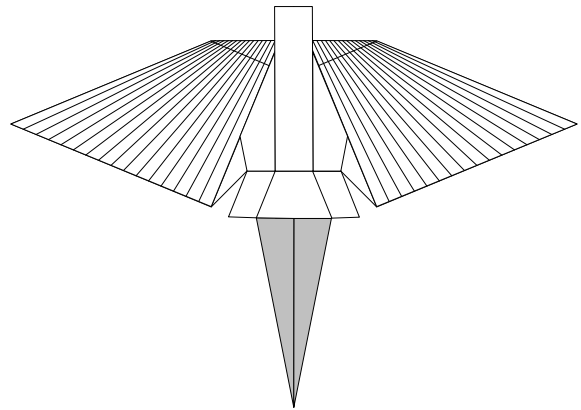
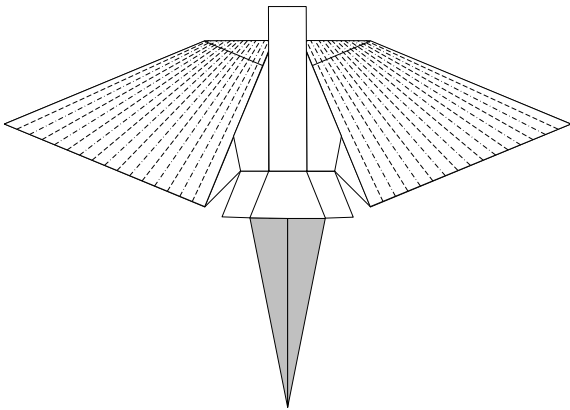

33

form the wings as fanfold (1/8 or 1/16)

34

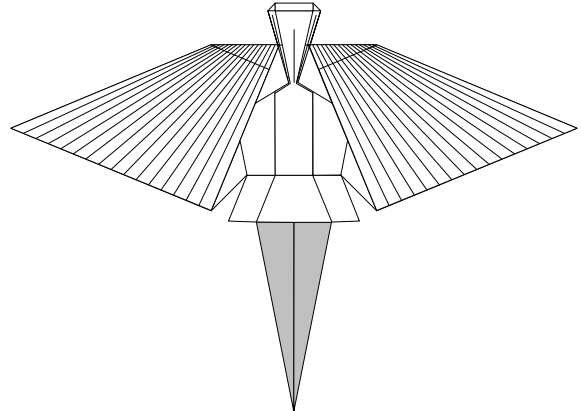
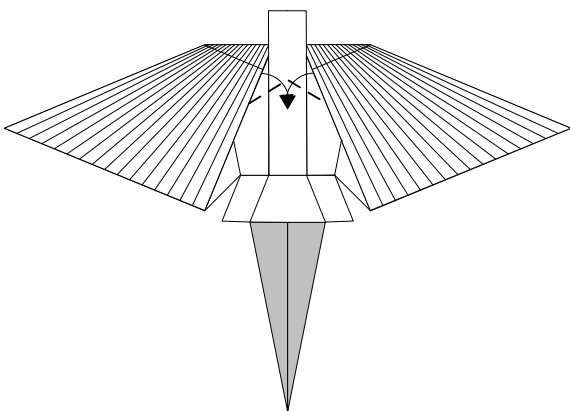

35

pull the head down to take the half layer from the left and the half layer from the right side

36

form the face and the hair